

Thermopile Sensor TS105-3

Rev. 2: 21st June 2007

The TS105-3 is a thermopile sensor for use in contactless temperature measurement

Thermopiles are mainly used for contactless temperature measurement in many applications. Their function is to transfer the heat radiation emitted from the objects into voltage output. Major applications are appliances like microwave oven, clothes dryer, automatic cooking, medical devices like ear and forehead thermometer, automotive applications like car climate control, seat occupancy, blind spot alert, black ice detection, consumer products like printer, copier, mobile phone and many industry applications like paper web, plastic parts etc.

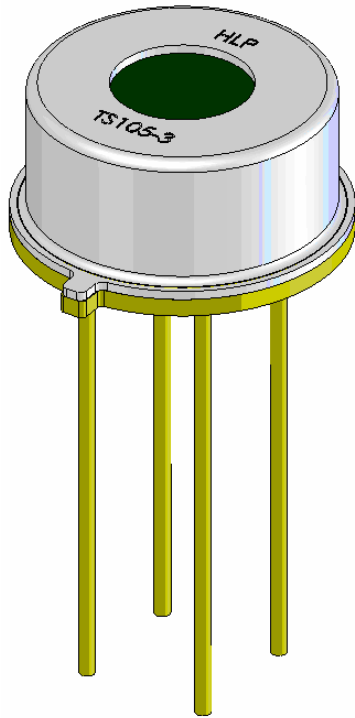

Parameter	Typical	Condition
Package	TO-5	
Absorber Area	0.7×0.7 mm ²	
Resistance of Thermopile	43±8 kΩ	+25 °C
TC of Resistance	-0.06±0.04 %/K	+25 °C → +75 °C
Thermopile Voltage	3.3±0.85 mV	+25 °C, BB +100 °C, DC totally filled field of view
TC of sensitivity	-0.45±0.08 %/K	+25 °C → +75 °C
Noise Equivalent Voltage	30 nV/Hz ^{1/2}	+25 °C
Rise Time	20±5 ms	τ ₆₃
Field of View	90°	
Filter	8-14 μm	band pass
Operation Temperature	-20 ... +85 °C	
Operation Temperature	-20 ... +100 °C	non permanent
Ambient Temperature Sensor	Ni-RTD	
Resistance	1000±4 Ω	0 °C
TC of Resistance	6178±150 ppm/K	0 °C → +100 °C
Connections		
Pin 1	TP -	
Pin 2	TP +	
Pin 3	Ni-RTD	
Pin 4	GND	

Mechanical Dimensions

TOP VIEW

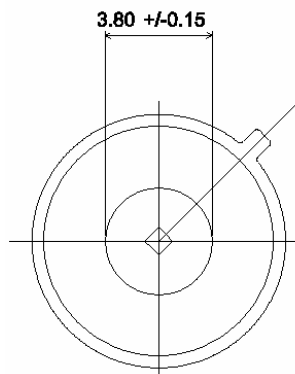

SIDE VIEW

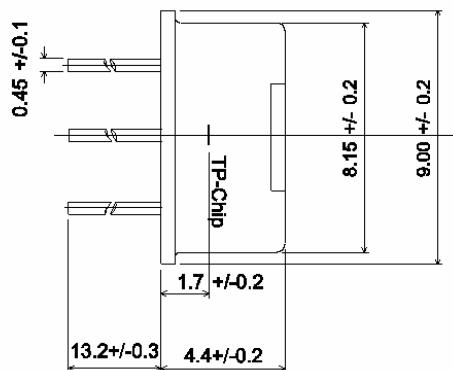

BOTTOM VIEW

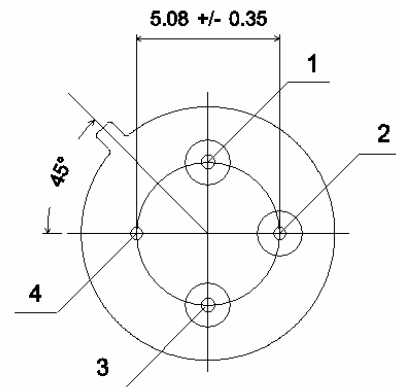

Thermopile Sensor TS105-3

Rev. 2: 21st June 2007

Connections Bottom View

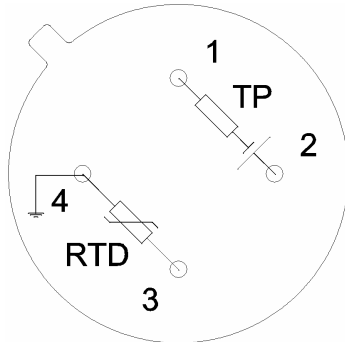

Filter Transmission

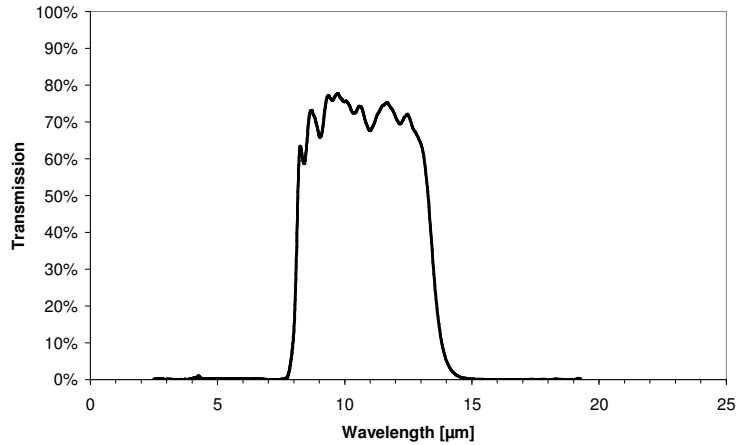

Thermopile Signal

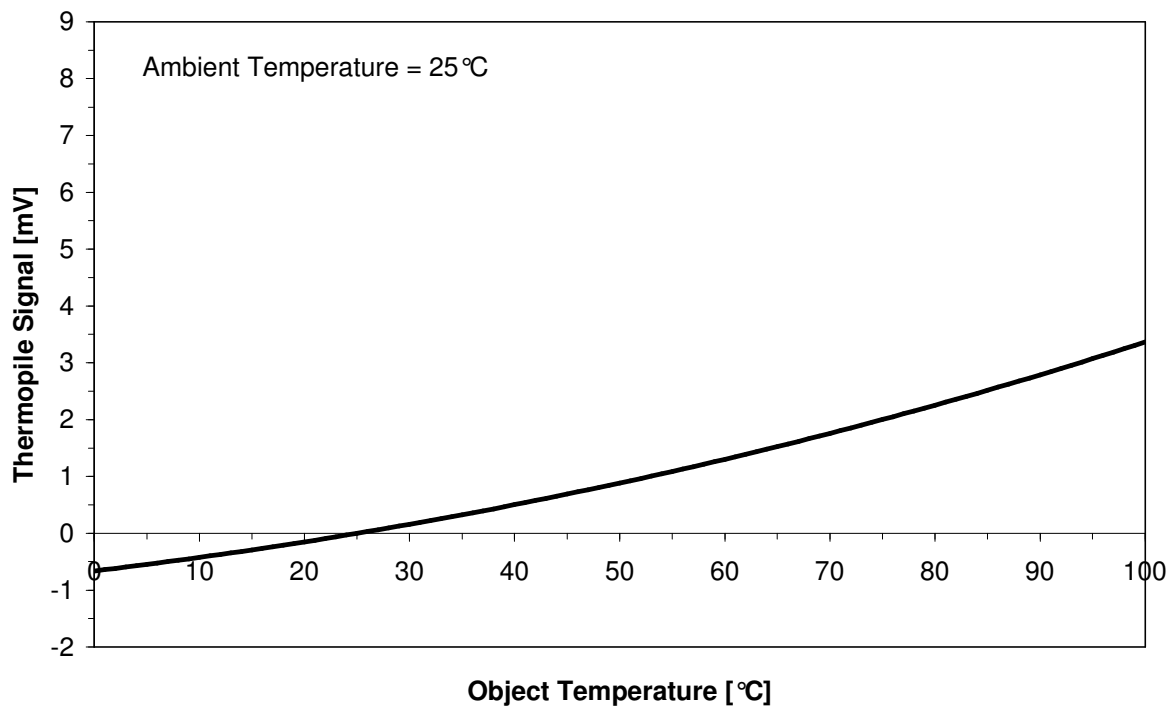

Additional products with different filters and packages are also available. Specifications are subject to change without notice !

Temperature Products Group

Design/Sales Europe	Ballybrit Business Park	Galway, Ireland	+353 91 753238	www.betatherm.com
Sales North America	910 Turnpike Road	Shrewsbury, MA 01545	+508 8420516	www.betatherm.com
Design Centre North America	2670 Indian Ripple Rd.	Dayton, OH 45440	+937 4271231	www.meas-spec.com
Design/Sales Europe	Hauert 13, D-44227	Dortmund, Germany	+49 23197400	www.hlplanar.com
Measurement Specialties	1000 Lucas Way	Hampton, VA23666	+757 7664297	www.meas-spec.com

深圳市杰晟兴电子有限公司 JM Components Limited

地址：深圳市福田区中航路7号鼎诚国际大厦南座2007室

手机：13662266995 马少良 电话：0755-83951311

官网：cn-sensor.com

邮编：518031

传真：0755-83952401

电邮：jackson@jmcomponents.com