

DATA SHEET

Liquid Level Switch

Optomax Digital







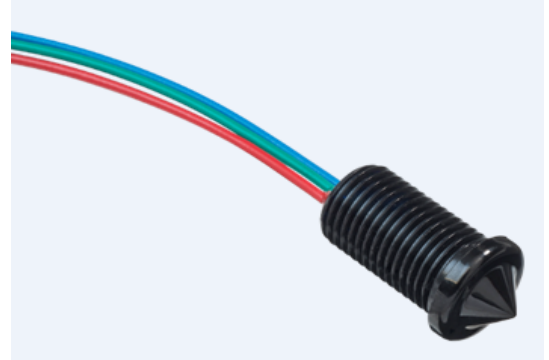

LLC510D3

FEATURES

Optomax Digital liquid level switches are ideal for applications with restricted space that require a miniature, low power and low cost sensing solution.

The microcontroller based sensor is solid state, incorporating an infra-red LED and phototransistor which are optically coupled by the tip when the sensor is in air. When the sensing tip is immersed in liquid, the infra-red light escapes making the output change state.



<p>Housing/ Mounting</p> 	<p>Output Type / Logic</p>   	<p>Supply Voltage</p>  <p>4.5 - 15.4 V VOLTAGE</p>	<p>Output Current</p>  <p>UP TO 100mA CURRENT</p>	<p>Temp</p>  <p>-25°C to +80°C TEMPERATURE</p>  <p>-40°C to +125°C TEMPERATURE</p>
---	--	--	--	--

TECHNICAL SPECIFICATIONS

Supply voltage (Vs)	4.5V _{DC} to 15.4V _{DC}
Supply current (Is)	2.5mA max. (Vs = 15.4V _{DC})
Output sink and source current (Iout)	100mA
Operating temperatures	Standard: -25°C to +80°C Extended: -40°C to +125°C
Storage temperatures	Standard: -30°C to +85°C Extended: -40°C to +125°C
Housing material	Trogamid® or Polysulfone ¹
Sensor termination	24AWG, 250mm PTFE wires, 8mm tinned
Mounting thread ²	M10x1 ³
Operating pressure	20bar ⁴
Tightening torque	1.5Nm / 13.26 in-lb maximum

OUTPUT VALUES

Output Voltage⁵ (Vout):	Iout = 100mA
Output High	Vout = Vs - 1V max
Output Low	Vout = 0V + 0.5V max

NOTES

- 1) Before use check that the fluid in which you wish to use these devices is compatible with Polysulfone.
- 2) Sensor is mounted from inside vessel.
- 3) Hex nut and O-ring sold separately.
- 4) When correctly sealed.
- 5) Voltages applicable to output value stated.

OUTLINE DRAWING

All dimensions shown in mm. Tolerances = ±1mm.

Sensor mounted from inside vessel

LLx5x0 Series

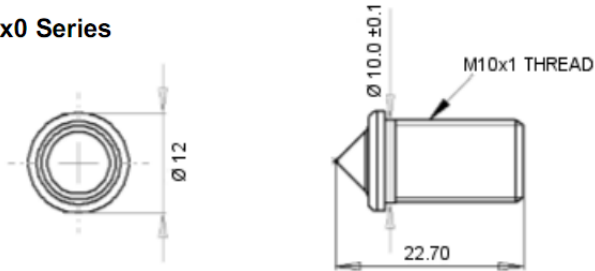

ELECTRICAL INTERFACE

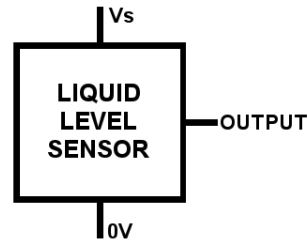

Wire	Designation
Red	Vs
Green	Output
Blue	0V

CIRCUIT DIAGRAM

Digital Output High in Air

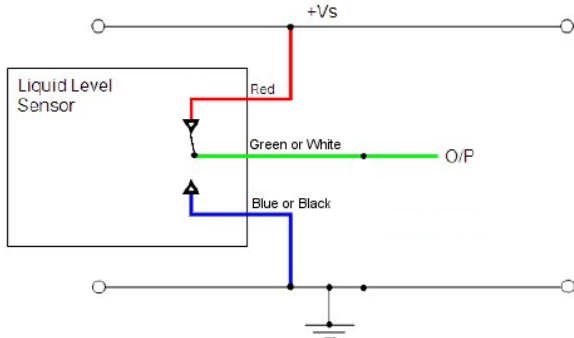

CAUTION: Take care when connecting loads.

The minimum load impedance should not exceed $V_s/\text{max output current}$.

NOTE: Shorting the output to V_s or $0V$ will result in irreparable damage to the sensor.

ORDER INFORMATION

Specify the part number listed below when ordering.

L	L	X	5	X	0	D	3	X
↓			↓		↓			
Housing Material			Operating Temp.		Output Logic			
C Polysulfone			0 -25 °C to +80°C		Blank Output High in air			
T Trogamid®			1 -40 °C to +125°C		L Output Low in air			

CAUTION

Do not exceed maximum ratings and ensure sensor(s) are operated in accordance with their requirements.

Carefully follow all wiring instructions. Incorrect wiring can cause permanent damage to the device.

Apollo Sensing Ltd recommend using alcohol based cleaning agents. Do NOT use chlorinated solvents such as trichloroethane as these are likely to attack the sensor material.

Failure to comply with these instructions may result in product damage.

INFORMATION

As customer applications are outside of Apollosense Ltd.'s control, the information provided is given without legal responsibility.

Customers should test under their own conditions to ensure that the equipment is suitable for their intended application. Before use, check that the fluid in which you wish to use these devices is compatible with Polysulfone.

General Note: Apollo Sensing Ltd. reserves the right to make changes to product specifications without notice or liability. All information is subject to Apollo Sensing Ltd.'s own data and considered accurate at time of going to print.



深圳市杰晟兴电子有限公司 JM Components Limited

地址：深圳市福田区中航路7号鼎诚国际大厦南座2007室

手机：13662266995 马少良 电话：0755-83951311

官网：cn-sensor.com

邮编：518031

传真：0755-83952401

电邮：jackson@jmcomponents.com