



SDP8405

Silicon Phototransistor

FEATURES

- T-1 plastic package
- 20° (nominal) acceptance angle
- Consistent optical properties
- Wide sensitivity ranges
- Mechanically and spectrally matched to SEP8505 and SEP8705 infrared emitting diodes

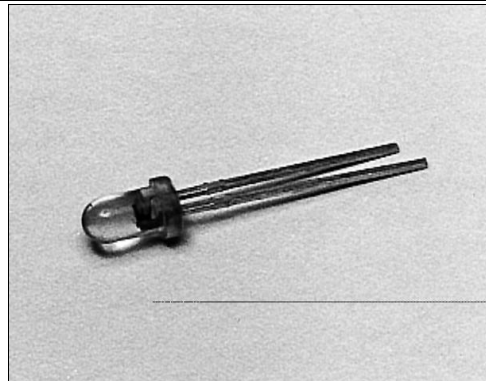

INFRA-22.TIF

DESCRIPTION

The SDP8405 is an NPN silicon phototransistor transfer molded in a T-1 clear plastic package. Transfer molding of this device assures superior optical centerline performance compared to other molding processes. Lead lengths are staggered to provide a simple method of polarity identification.

OUTLINE DIMENSIONS in inches (mm)

Tolerance 3 plc decimals $\pm 0.005(0.12)$
2 plc decimals $\pm 0.020(0.51)$

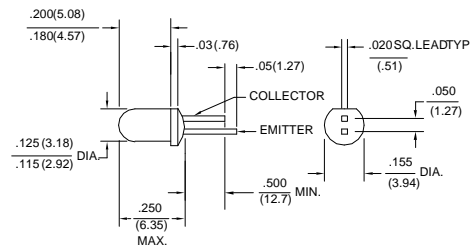

SDP8405

Silicon Phototransistor

ELECTRICAL CHARACTERISTICS (25°C unless otherwise noted)

PARAMETER	SYMBOL	MIN	TYP	MAX	UNITS	TEST CONDITIONS
Light Current SDP8405-001 SDP8405-002 SDP8405-003	I_L	1.00 7.00 12.0		14.0 24.0	mA	$V_{CE}=5\text{ V}$ $H=5\text{ mW/cm}^2$ ⁽¹⁾
Light Current SDP8405-011 SDP8405-012 SDP8405-013 SDP8405-014 SDP8405-015	I_L	0.16 0.16 0.32 0.64 1.25		0.46 0.92 1.85	mA	$V_{CE}=5\text{ V}$ $H=0.25\text{ mW/cm}^2$ ⁽²⁾
Collector Dark Current	I_{CEO}			100	nA	$V_{CE}=15\text{ V}$, $H=0$
Collector-Emitter Breakdown Voltage	$V_{(BR)CEO}$	30			V	$I_C=100\text{ }\mu\text{A}$
Emitter-Collector Breakdown Voltage	$V_{(BR)ECO}$	5.0			V	$I_E=100\text{ }\mu\text{A}$
Collector-Emitter Saturation Voltage SDP8405-001 to -003 SDP8405-011 to -015	$V_{CE(SAT)}$			0.4	V	$I_C=I_L/8$ $H=5\text{ mW/cm}^2$ $H=0.25\text{ mW/cm}^2$
Angular Response ⁽³⁾	\emptyset		20		degr.	$I_F=\text{Constant}$
Rise And Fall Time	t_r, t_f		15		μs	$V_{CC}=5\text{ V}$, $I_L=1\text{ mA}$ $R_L=1000\text{ }\Omega$

Notes

1. The radiation source is a tungsten lamp operating at a color temperature of 2870°K.
2. The radiation source is an IRED with a peak wavelength of 935 nm.
3. Angular response is defined as the total included angle between the half sensitivity points.

ABSOLUTE MAXIMUM RATINGS

(25°C Free-Air Temperature unless otherwise noted)

Collector-Emitter Voltage	30 V
Emitter-Collector Voltage	5 V
Power Dissipation	70 mW ⁽¹⁾
Operating Temperature Range	-40°C to 85°C
Storage Temperature Range	-40°C to 85°C
Soldering Temperature (5 sec)	240°C

Notes

1. Derate linearly from 25°C free-air temperature at the rate of 0.18 mW/°C.

SCHEMATIC

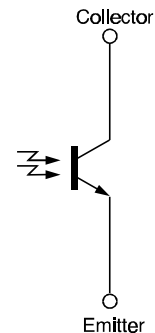

SDP8405

Silicon Phototransistor

SWITCHING TIME TEST CIRCUIT

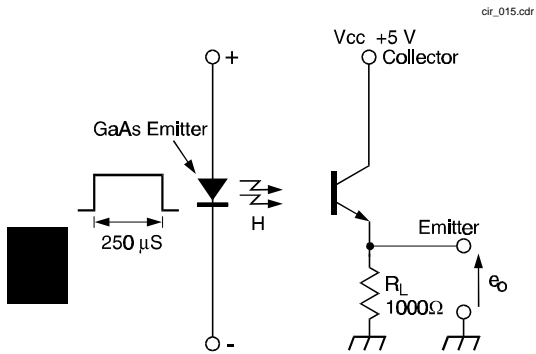

Fig. 1 Responsivity vs Angular Displacement

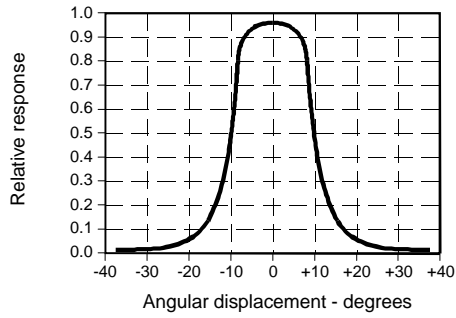
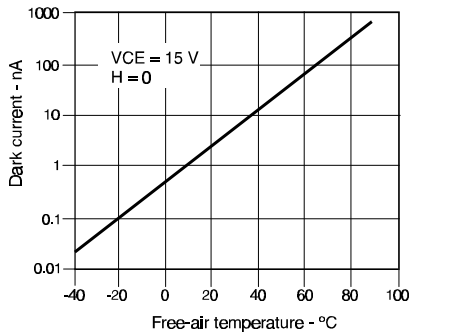

Fig. 3 Dark Current vs Temperature



SWITCHING WAVEFORM

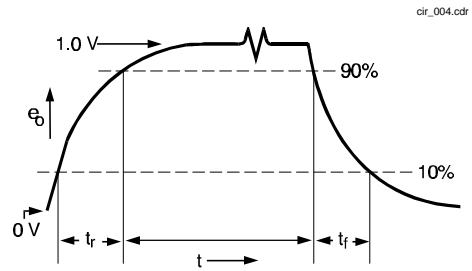

Fig. 2 Collector Current vs Ambient Temperature

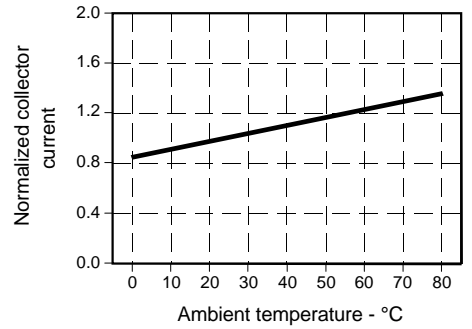
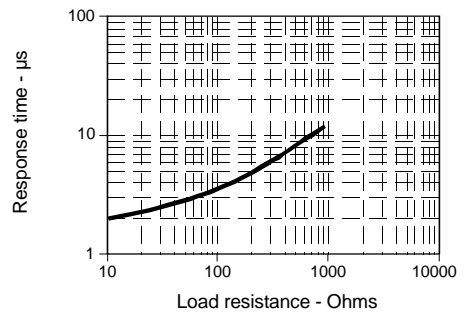

Fig. 4 Non-Saturated Switching Time vs Load Resistance



SDP8405

Silicon Phototransistor

Fig. 5 Spectral Responsivity

gra_036.ds4

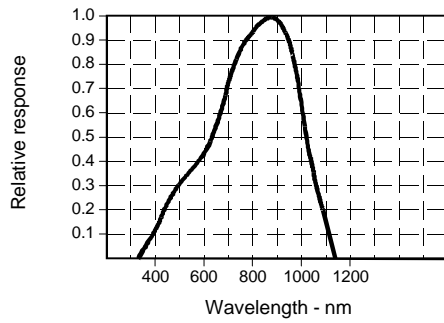
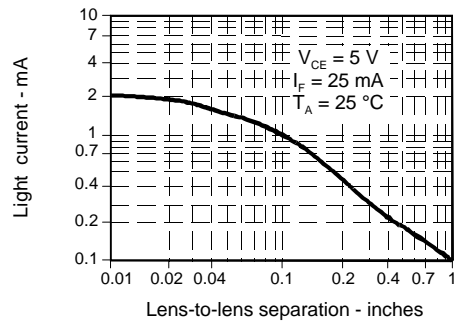

Fig. 6 Coupling Characteristics with SEP8505

gra_029.ds4



All Performance Curves Show Typical Values

深圳市杰晟兴电子有限公司 JM Components Limited

地址：深圳市福田区中航路7号鼎诚国际大厦南座2007室
手机：13662266995 马少良 电话：0755-83951311
官网：cn-sensor.com

邮编：518031
传真：0755-83952401
电邮：jackson@jmcomponents.com